

# SubConn® Low Profile

## 9 contacts

### Connector specifications

Voltage rating	600 V AC rms
DC rating	85% of above AC rating
Current rating	10 A per contact (max 40 A per connector)
Insulation resistance	> 200 Mohm
Contact resistance	< 0.01 ohm
Wet matings	> 500
Temperature rating (water)	- 4 to 60°C, 25 to 140°F
Temperature rating (air)	- 40 to 60°C, - 40 to 140°F
Storage temperature rating	- 40 to 60°C, - 40 to 140°F
Depth rating	700 bar, 10,000 psi
Depth rating PEEK	300 bar, 4,350 psi

### Material specifications

Connector body	Chloroprene rubber
Bulkhead body	Brass, stainless steel, titanium, anodised aluminium or PEEK
Contacts	Gold plated brass UNS - C36000
O-rings	Nitrile
Locking straps	Chloroprene rubber
Inline cable (60 cm, 2 ft)	16 AWG 1.31 mm <sup>2</sup> chloroprene rubber
Bulkhead leads (30 cm, 1 ft)	18 AWG 0.82 mm <sup>2</sup> tagged PTFE

### Face view (male)



### Inline cable colour code

1 Black	4 Green	7 White/black
2 White	5 Orange	8 Red/black
3 Red	6 Blue	9 Green/black

### Nominal cable outside diameter (OD)

9 conductor cable 0.590", 15.0 mm

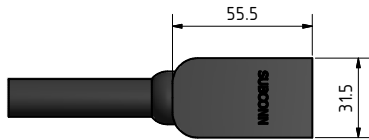

LPIL9F

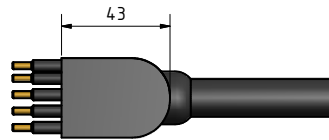

LPIL9M

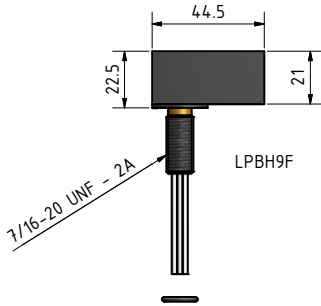
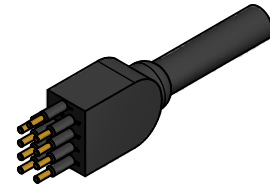

LPBH9F

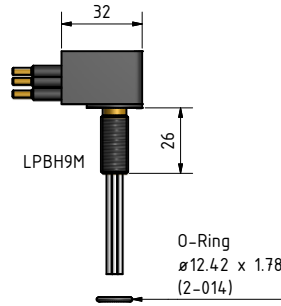

LPBH9M

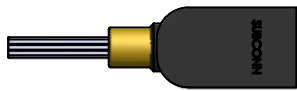
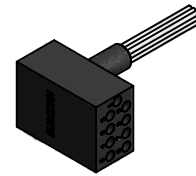

LPOM9F

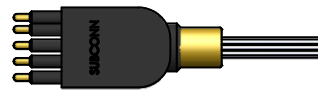

LPOM9M

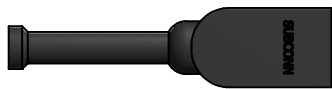
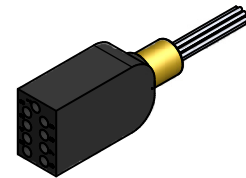

LPDC9F

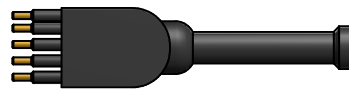

LPDC9M

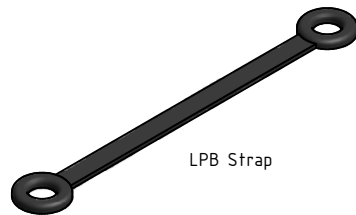
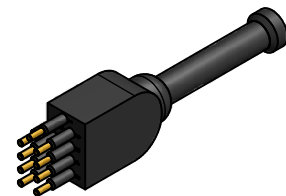

LPB Strap

**Drawing information**

Dimensions in mm (1 mm = 0.03937 inch)  
Threads in inches (1 inch = 25.4 mm)